

DRAFT

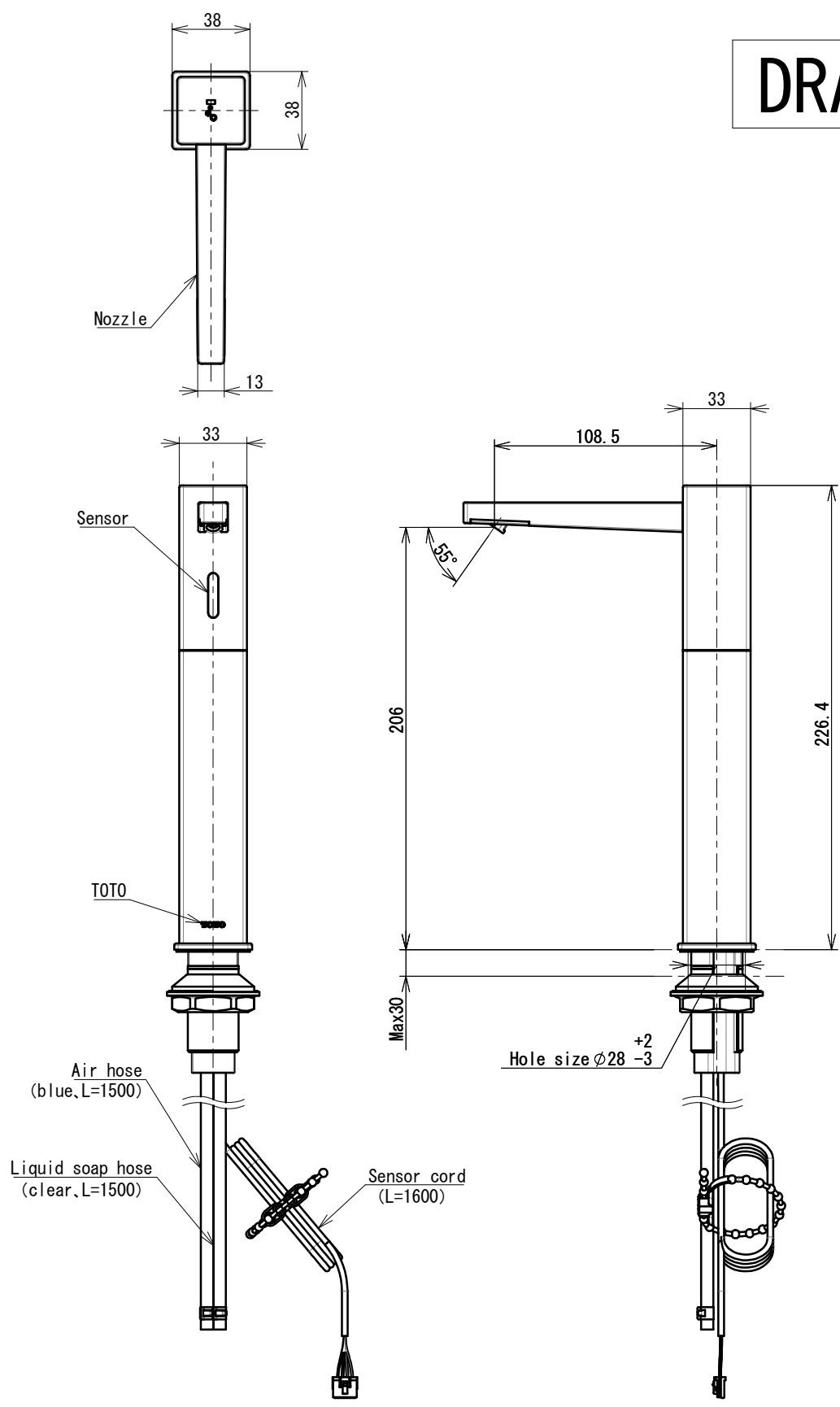

TOTO			UNIT mm	TITLE Touchless Soap Dispenser
DR. BY 山内	CH. BY 村橋	DATE 2020/10/20	SCALE 1:3	ITEM NO. TLK08003G
COMMENTS				DRAWING NO. -